



## OWNER'S MANUAL

# PRICE COMPUTING SCALE



PC HS Series

BEFORE OPERATING THIS SCALE, PLEASE READ THIS MANUAL THOROUGHLY



# INDEX

Important warnings	3
Introduction	5
Installation guide	5
Name and location of general parts	6
Keyboard	7
LCD display screen	9
Description of operations	10
How to weigh a product	10
How to enter prices	10
"Fixed price" function	11
How to use "TARE" function	11
How to use "Reference ZERO" function	12
Price ADD-UP	12
How to store prices in the scale's memory	12
How to load prices from the scale's memory	12
Recharge battery	13
Serial connection with PC	13
Important messages displayed	14
Maintenance and cleaning	16
Troubleshooting guide	17
Technical specifications	18
Additional data	19

## IMPORTANT WARNINGS

1. In case you have any problem with the scale, read the warranty conditions.



2. Do not open the scale on your own. Your warranty will be canceled.



3. Do not press the keyboard with any sharp and/or pointed objects.



4. Use a VAC outlet exclusive for the scale, avoiding overloads or voltage variations.



5. Do not wash the scale using flow of water. This can damage the electronic components. For more information read "Maintenance and cleaning" section



6. Protect the scale from insects; they can damage the electronic components. Use online solid products against insects.



7. Do not drop or hit the scale with the product to be weighted, this will damage the weight sensor.





**IMPORTANT WARNINGS**

8. Do not use solvents or detergents for cleaning, use only a damp towel.

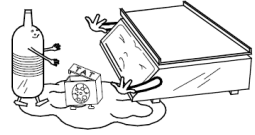

9. Do not place any fans or heaters towards the scale.

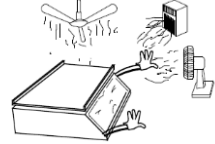

10. Do not place the scale where there is excess of moisture or dust.



11. Only authorized and qualified staff should check and repair the scale.



**IMPORTANT**



Battery should be recharged for 10 hrs before using the scale for the first time.

**WARNING**



**Do not open the scale**

Caution: to reduce the risk of short circuit in your scale, do not remove the cover or substitute any of the parts for others that are not original only authorized distributor.

## INTRODUCTION

Dear customer:

We appreciate that you have chosen this product. We assure you that you will get the maximum satisfaction of the new acquisition for your business. We suggest you to read carefully this manual and make sure to keep it at hand for later consultations.

## INSTALLATION GUIDE

1. Unpack the scale and check that it is in good condition. If you find any damage, notify your authorized dealer immediately.



2. Set the scale in a free movement and vibrations place. Verify that it is right levelled.



3. Connect the source adapter to VAC outlet of 110/220VAC, (if it is necessary).



4. Turn on the scale and the viewer / screen will show:

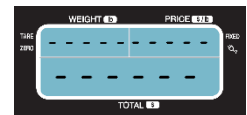

**IMPORTANT NOTE:** By performing the steps described above, the scale shows the word "HELP" it means that it was mistreated and / or hit during transport, which caused irreversible damage. If so, contact your authorized distributor. It is also possible that the scale shows "HELP" when it is lit with a product on the plate, in this case, remove the weight from the scale, turn it off and then on again.

## NAME AND LOCATION OF GENERAL PARTS

1. **CABINET:** Stainless steel resistant to corrosion.
2. **PLATE:** Food grade, stainless steel with bent and rounded borders.
3. **PLATE HOLDER:** Manufactured in aluminum, resistant to corrosion.
4. **KEYBOARD:** Fast response, legible and easy to handle keyboard.
5. **DISPLAY:** Liquid cristal display.
6. **ADJUSTABLE LEVELING BASES:** Loose or tight up them to adjust the scale.
7. **INPUT ADAPTER:** DC power supply connection, located at the base of the scale.
8. **LEVEL INDICATOR:** Used as a scale's leveling reference.
9. **POWER SUPPLY:** 110/220 VAC to 6VDC Switching adapter (included).
10. **SERIAL CONNECTOR:** Connect the scale with a PC or printer using a RS232 cable.
11. **TURRET DISPLAY:** Turret with large digit display (Available for PC40LT-HS and PC80LT-HS).

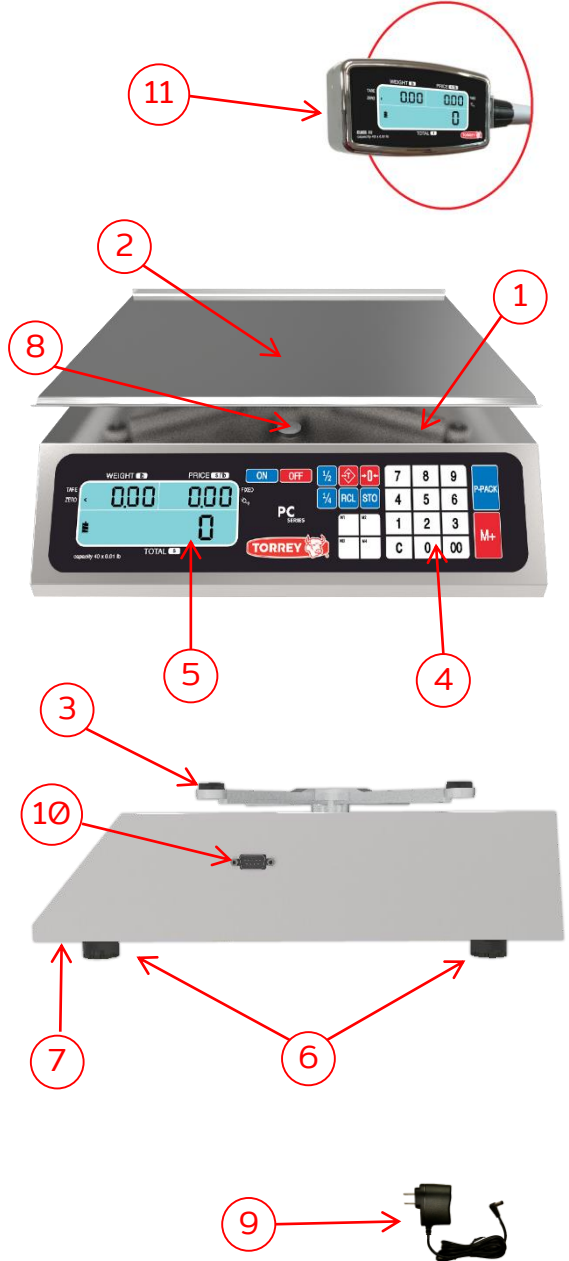

## KEYBOARD

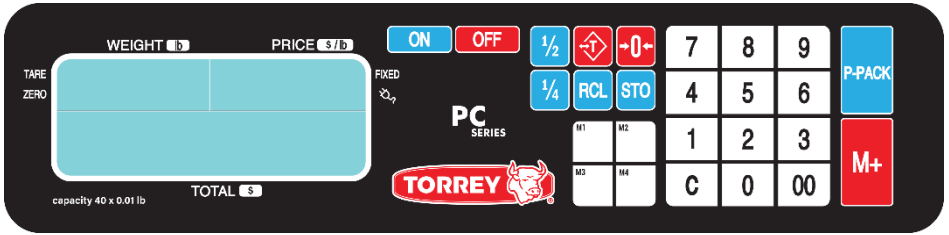

Press to turn the scale ON



Press to turn the scale OFF



Press to set the scale to zero weight.



Press to eliminate any container's weight that you do not want to consider during a trade.



Is used to store prices data on the 99 scale's memory.



Press to load a price previously saved in the 99 scale's memory.



Press to activate the fixed price function.



Press to add total amounts per transaction onto your scale.



## KEYBOARD

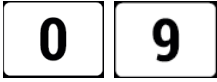

Enter prices.



Use to enter a double 0 to the price



Press to clear the price.  
In Add up mode, erase the total transaction.



Used to multiply the price by  $\frac{1}{2}$  or  $\frac{1}{4}$



Read directly price values previously saved from 1 to 4  
Save directly price values previously set from 1 to 4



## LCD DISPLAY SCREEN

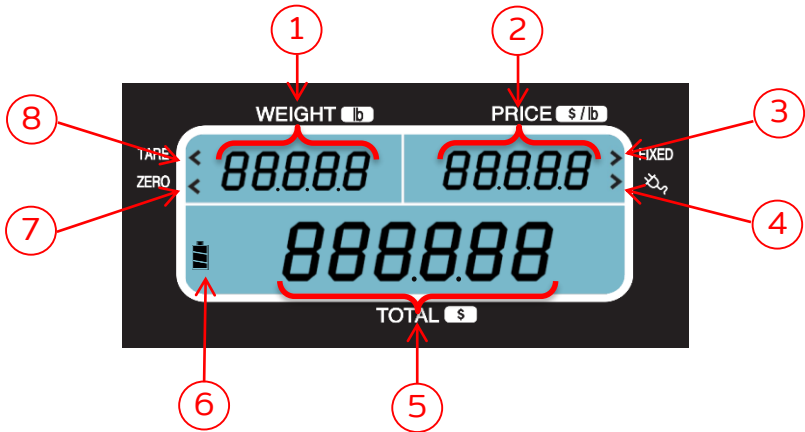

1. WEIGHT INDICATOR: Shows product's weight.
2. PRICE INDICATOR: Indicates the product's price per pounds.
3. "FIXED PRICE" INDICATOR: Shows that the product's price would not be deleted when the product is removed from the scale. Do not allow to modify the price, only de-activating the fixed price function.
4. AC/DC POWER SUPPLY INDICATOR: Shows the scale is connected to the power outlet.
5. TOTAL INDICATOR: Shows the total amount to charge per product during a sale. (Weight x price).
6. BATTERY INDICATOR: Shows charge level of the battery.
7. "ZERO": Shows when scale is in zeros and ready to weight. It disappears when a product is placed on the plate.
8. "TARE": Indicates the "TARE" function is active. Goes off when the function is de-activated.



## DESCRIPTION OF OPERATIONS

### How to weight a product

Turn the scale on, wait for the screen to display zero. Place the product to be weighted on the scale and the "lb" weight will be displayed on the "WEIGHT" indicator.

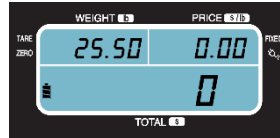
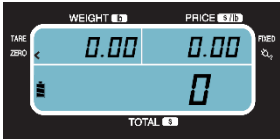

### How to enter prices

To enter a price per pound for a product, type the product's price on the keypad. It will appear on the "PRICE" indicator and the total sale will be shown at the "TOTAL" indicator. When the product is weighted, the scale will show the result automatically (Weight x Cost per lb = Total sale)

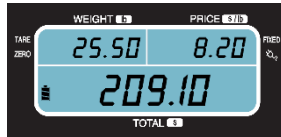

Deleting an assigned price can be done manually or automatically.

- Manually: To modify the assigned price, press the "C" key and assign the new value.
- Automatically: The price would be automatically deleted when the product is removed from the scale. (Except if the "Fixed Price" function is active).

## “Fixed price” function

The "Fixed price" function is used when a product requires to be constantly weighted. When the function is active, the price will remain on the display although the price is cleared from the scale. To fix a price, place the product on the scale's plate, type the cost per lb of the product and press the "P-PACK" key. The P-PACK indicator will be turned on. To deactivate it, clear the price by pressing the "C" key or press "P-PACK" key again.



## How to use "TARE" function

Press the "->T<-" key to get the scale to zeros, eliminating the weight of any container. To deactivate the function remove the container and press the "->T<-" key again. To sum up follow the next sequence:

1. Place the empty container on the scale.
2. Press the "->T<-" key to set the scale back to zero. Scale with container on it ready to use.
3. If the container is removed a negative number (the container's weight) will display. You can deactivate it by pressing ->T<- key again.



1.



2.



3.

It is important to mention that this function is subtractive from the scale's maximum capacity. For example if you have a container that weights 7 lb The scale will only be able to weight up to 33 lb of product to complete the maximum capacity.

## How to use the "Reference ZERO" function

If the scale shows weight on display without having any product on it, it might be due to a voltage variation, rough use, or another factor. Just press the "->0<-" key and the display will return to zeros.

## Price ADD-UP

To add prices up follow the next steps:

1. Place a product to weight on the plate, type the price and press "M+" key (for example: a price of \$2.20 and a weight of 1.50 lb).
2. Remove the product.
3. Place another product followed by the unit price and press "M+" key again.
4. To visualize the total sum without adding any price up press "M+" key when in zero.

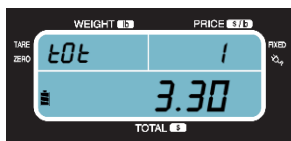

1.



2.

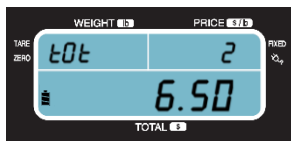

3.

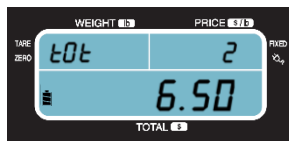

4.

## How to store prices in the scale's memory

1. Type the price to save
2. Press "STO" key
3. Type in the memory slot to save from (00-99) you can also press any of the direct access keys "M1 ... M4".
4. Once you complete last steps you will hear a confirmation alarm.

## How to load prices from the scale's memory

Press the "RCL" key followed by the memory slot (00-99) to load or press any of the direct access keys "M1 ... M4". An example sequence below:

If you have saved \$26.60 in the memory slot 4, follow these steps to load:

1. Press "RCL" key
2. Type 0, 4 or press M4, and the price stored in the memory, will be displayed on the "PRICE" indicator, in this case \$26.60





You are able to use SCALE v2.x software to show weight measurement on your PC or laptop screen.

**\*Installing:** Please download the scale software from our web site <http://www.torrey-cloud.com/downloads/> (identify the "PPT Torrey Software" section and proceed to download).

**\*System requirements:** Windows 7 or Windows 10 (32 or 64 bits)

## IMPORTANT MESSAGES DISPLAYED

### LOW BATT

If this message appears in intervals on display, it indicates that the scale needs to be recharged. Even with this advice the scale can continue working for 30 minutes. If it appears and after a few seconds the scale turns off, it means that the scale is completely discharged. At this point the scale will not work and all of the operations being performed at the time will be lost.



To solve the problem connect the AC/DC power supply for a period of time of 10 hours. In case the scale needs to be used while charging, this will not cause any issues, but it will only take longer to fully charge.

### OVER LOAD

This message indicates that a weight that exceeds the maximum capacity has been placed on the scale. To correct it, simply remove the overweight .



## HELP

This message appears in two different situations:

1. When the scale is turned on with an excess weight on the plate near half the scale's capacity. To correct this situation remove the weight on the scale, turn the scale off, and then back on again.
2. When the scale has been handled roughly and/or hit.



## NEGATIVE WEIGHT

This message indicates a negative weight to fix this place back in its plate and press the "->0<-" key, or turn the scale off and then turn it on again.

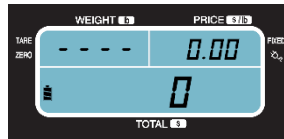

## PLS UNLOAD

This message appears when the scale was turned on with a weight on the plate. To quit this message remove the weight, turn off the scale and then turn it on again.



## TOTAL "-----"

This message indicates that the limit has been exceeded when the multiplication price per weight exceeds the 9999.99, if this happens, lines at "TOTAL" indicator will appear.

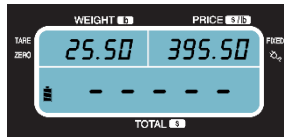



## **MAINTENANCE AND CLEANING**

---

One of the greatest advantages of purchasing this scale model is that it requires minimum maintenance and it is very simple to keep it in favorable conditions.

- Do not use a flow of water to clean your scale. Use a damp rag and clean each of these components daily: plate and keyboard.
- To remove oil and greasy substances, use a dry and clean rag, rubbing dirty area several times.
- Do not use detergents or corrosive liquid while cleaning.
- Do not place the scale where there is a lot of moisture and/or dust.
- When you clean the scale make sure that there are not any papers, pieces of meat or any other kind of material under the plate or under the plate-holder that could obstruct the adequate operation of your scale.
- Periodically check the jack (where the AC/DC power supply is inserted) to make sure it is in good condition. That is, check there are not signs of strokes or detachments.
- Periodically check the AC/DC power supply to make sure the ends are in good condition. And that the cable is not twisted or tangled.
- Regularly check the scale to assure it is correctly leveled with its four leveling bases well supported.
- Do not expose your scale to temperatures below 14°F (-10°C) or for above 104°F (40°C).
- Never press the keyboard with objects such as pencils, pens, knives, etc.
- Do not drop or hard weight on the plate or the scale because with the time it could damage the load cell.



## **TROUBLESHOOTING GUIDE**

Before you call for service to your authorized distributor, check this manual again to avoid a misunderstanding.

<b>PROBLEM</b>	<b>POSSIBLE CAUSE</b>	<b>SOLUTION</b>
The scale does not turn on	There is not electric current.	With a multimeter check the current outlets.
	AC/DC power supply cable has an unconnected wire or defectuous voltage outlet.	Check the AC/DC power supply terminals, if it is possible, check with another AC/DC power supply.
	Low battery.	Connect the AC/DC power supply and verify that the battery is been recharged. If not replace the battery
The scale shows different weights with the same product	Material under the plate.	Check if exists materials under the platform. If so, remove them and check the operation again.
The word "HELP" appears in the display	The scale was turned on with a weight over the plate.	Remove the weight, turn off the scale and then turn it on again.

## TECHNICAL SPECIFICATIONS

PC40L-HS / LT-HS	PC80L-HS / LT-HS
<p>MAX. 40 lb            MIN. DIV. 0.01 lb            MAX TARE 40 lb            MAX PRICE / lb \$ 999.99            MAX IMPORT \$ 9999.99            OPER. TEMP. -14°F to 104 °F</p>	<p>MAX. 80 lb            MIN. DIV. 0.02 lb            MAX TARE 80 lb            MAX PRICE / lb \$ 999.99            MAX IMPORT \$ 9999.99            OPER. TEMP. -14°F to 104 °F</p>

MAX: MAXIMUM CAPACITY.  
 MIN. DIV: MINIMUM DIVISION.  
 MAX TARE: MAXIMUM TARE.  
 MAX PRICE / lb: MAXIMUM PRICE PER lb  
 OPER TEMP: OPERATING TEMPERATURE.

POWER SUPPLY INPUT: 110/220VAC  
 POWER SUPPLY OUTPUT: 6VDC 500mA  
 BATTERY: 4VDC 2.5A/h

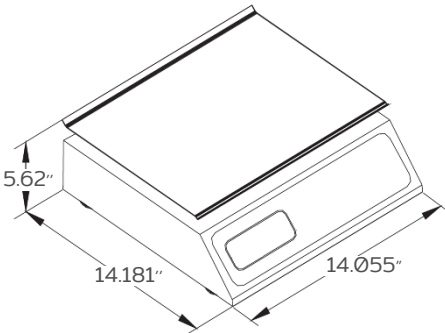

PC 40/80 L-HS

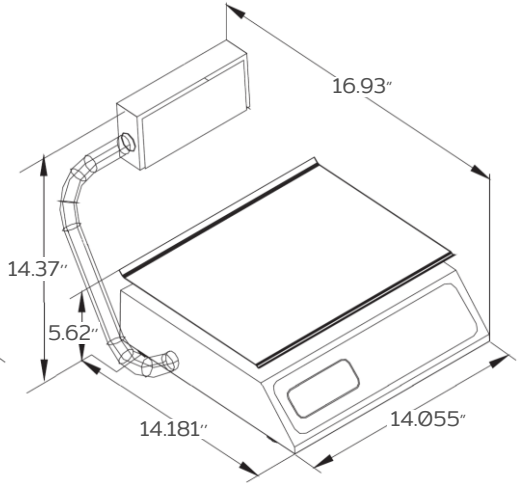

PC 40/80 LT-HS

## ADDITIONAL DATA

The serial number of this product can be found in the identification information which is located at the top of the scale's cabinet. We suggest you that write the serial number and the scale model in the following spaces and hold them as proof of your acquisition and as identification in case of loss or to future request.

Distributor \_\_\_\_\_

Address \_\_\_\_\_

Telephone number \_\_\_\_\_

Purchase date \_\_\_\_\_

Serial number \_\_\_\_\_

We reserve the right to change any specification contained in this text without prior notice.



ELECTRONIC  
SCALE

[www.torrey.net](http://www.torrey.net)